

SD1

SPEECH DIALLER



OPERATING INSTRUCTIONS

CONTENTS

Section	Title	Page
1	Overview	1
2	Initialising the SD1	2
3	Programming Telephone Numbers	2
4	Recording Messages	3
5	Message Replaying	4
6	Call Acknowledgement Procedure	4
7	Sending a Test Call	4
8	Test Activation.	6
9	Changing the Acknowledgement Option	7
10	Viewing the Last Call Log	8
11	Cancelling an Activation	8
12	Trouble-Shooting Guide	9
13	Quick Reference Guide	10

1. Overview

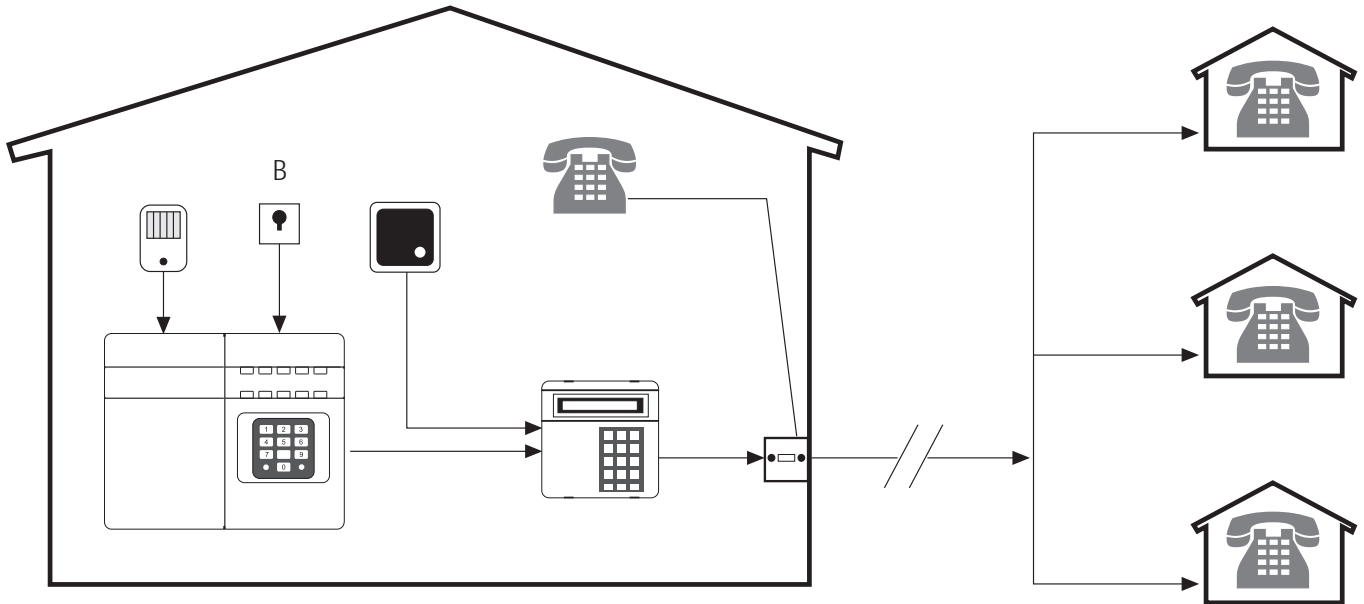

Connections: The SD1 is connected between the alarm control panel and the telephone line. It behaves like another extension to the telephone and does not affect its normal operation or that of any other extension fitted. However, if the SD1 is operating the messages will be heard if any handset is lifted. The unit requires no batteries as its power and mains fail back-up are derived from the alarm control panel.

The SD1 accepts three inputs which in our example are; A - Personal Attack (PA), B - burglary and C - fire. These correspond to the messages (A, B and C) that the SD1 sends out and should be recorded as such. If the control panel does not have a fire monitoring capability then the SD1 will accept a direct connection from a suitable smoke alarm (as above). The SD1 may also be included in the control panel tamper circuit.

Telephone Numbers: The SD1 will dial up to three different telephone numbers and play its message. The numbers may be up to 16 digits long and are simply programmed using the text display and keypad on the unit.

Messages: The SD1 has a built-in microphone and speaker so that phrases can be recorded and replayed directly from the unit. When the out-going call is answered the SD1 plays a common phrase (0) and one of the three alarm messages (phrases A, B or C). Phrase 0 states your name and address and phrases A, B and C relate to the inputs from the control panel (PA, burglary and fire in our example). Each phrase can be up to 8 seconds long giving a total possible message length of 16 seconds (0 + A, B or C).

Acknowledgement: On receiving a call from the SD1 the person answering acknowledges it by pressing the number [8] on their telephone*. The SD1 may be programmed to stop dialling after the first call has been acknowledged or when two or three have been acknowledged, as required.

If the message is not acknowledged then it is repeated four times after which the dialler abandons the call. It then dials the next number. This procedure is repeated three times in sequence for all three telephone numbers. If no acknowledgement has been received then the dialler shuts down.

* Certain older types of telephone may require a tone dialling simulator to do this.

SD1 Operating Instructions

2. Initialising the SD1

When the SD1 is switched on the display will show "PLEASE RE-RECORD" and the unit will beep every 30 seconds. This indicates that the memory is blank (i.e., all telephone numbers and messages are blank).

Display shows "PLEASE RE-RECORD" when unit is first switched on.

When initialised the display shows "READY", the unit can now be programmed and tested.

If the unit is not operated for 1 minute, it will revert to its normal standby mode and the display shows "-ON-".

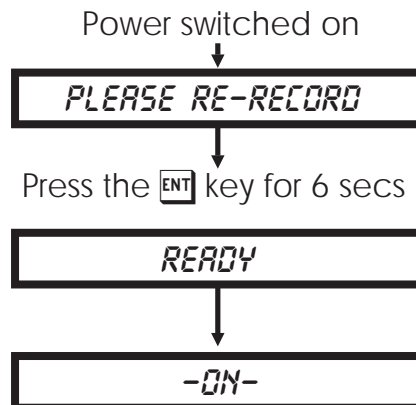

3. Programming Telephone Numbers

The SD1 stores up to three telephone numbers with a maximum of 16 digits for each.

NOTE. Permission of the person(s) that are being called must be obtained before storing their telephone number. The Emergency Services telephone numbers CANNOT be entered.

The following example shows how to set telephone number 1 as 081 1234567.

Ensure that the SD1 is initialised and the display is showing "READY".

Pressing 1-3 selects telephone numbers 1, 2 or 3. 0-C selects phrases 0, A, B or C (see section 4).

The display will alternate between "PHONE No. 1" and the current telephone number (Blank if the number has not been programmed).

Pressing the A key will clear the display if a mistake is made whilst entering the number.

Repeat for telephone number 2 and 3 as required.

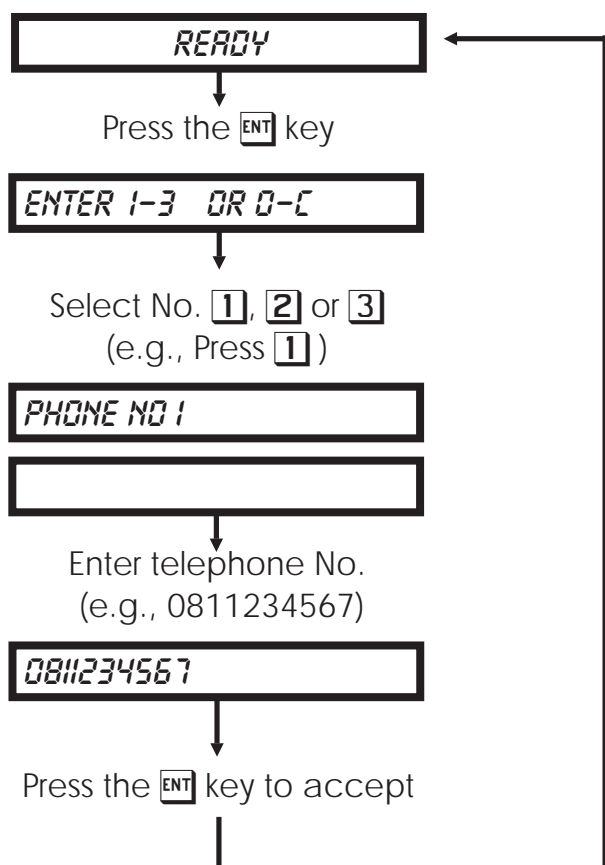

Programming Telephone Numbers (Cont.)

When the SD1 dials a telephone number it will automatically select the correct dialling format. In the U.K. there are two formats:

Pulse Dialling: This is the older format and is sometimes referred to as Loop Disconnect/LD.

Tone Dialling: This is the modern format and sometimes referred to as Multiple Frequency/MF.

Any or all of the telephone numbers can be selected to override the automatic format selection and be forced into dialling the number in one of the above formats if required.

Before entering the telephone number in the procedure, press the **[B]** key to select "Pulse Dialling" () or press the **[C]** key to select "Tone Dialling" ()

4. Recording Messages

The SD1 can record four phrases A, B, C and a common phrase 0. Each can be up to eight seconds long and the four phrases are used to form three messages A, B and C:

Message A = phrase 0 + phrase A.

Message B = phrase 0 + phrase B.

Message C = phrase 0 + phrase C.

Phrase 0 is normally used to store the name and address of the premises, whereas phrases A, B and C is normally used to store the type of alarm condition, e.g.,

Phrase 0: "This Is Mr Smith, at 10 The Strand, East Fincham"

Phrase A: "There is a Fire Alarm condition, there is a Fire Alarm condition"

Phrase B: "There is a Personal Attack Alarm, there is a Personal Attack Alarm"

Phrase C: "There is an Intruder Alarm condition, there is an Intruder Alarm condition"

Before you record phrases it is advisable to prepare them first by writing them down. The following example shows how to record the common phrase 0:

Ensure that the SD1 is initialised and the display is showing "READY"

Pressing the **[0]**, **[A]**, **[B]** or **[C]** key, selects phrases 0, A, B, or C.

Stand back about 6-8 inches from the unit. When ready press the **[ENT]** key to start recording, speak clearly into the unit. The display will count down the remaining time in seconds. If the phrase is less than eight seconds you can press the **[ESC]** key to end the recording.

Repeat for phrases A, B and C, as required.

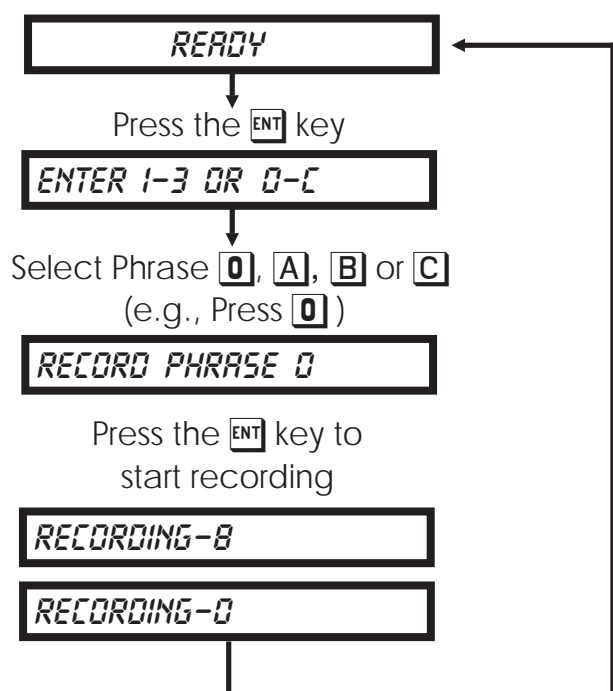

5. Replaying Messages

Once the phrases have been recorded it is possible to play them back through the built in loudspeaker.

The following example shows how to play back "Message A" (Phrase 0 + Phrase A):

Ensure that the SD1 is initialised and the display is showing "READY".

After a short delay the display will show "PLAYING PHRASE 0", then "PLAYING PHRASE A".

Repeat for messages B and C, as required.

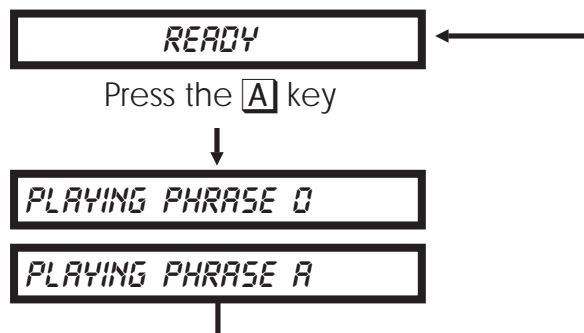

6. Call Acknowledgement Procedure

When the call is answered, the message is played. At the end of its message the SD1 sends an audible "beep" which must be answered within 2 seconds using the tone generated by pressing the [8] button on a standard telephone. On hearing the [8] tone the SD1 immediately sends another "beep" which must be answered in the same way. If successful, a multi-tone confirmation signal is then heard, if not then the message is repeated with the acknowledgement "beeps" again.

Points To Note:

1. The SD1 will not acknowledge signals from Pulse Dialling telephones or those with short duration tones. Check **all** recipients phones by calling them and getting them to press their [8] button. If a series of clicks is heard (or the tone cannot be sustained by holding down the button) then a Tone Dialling Simulator will be needed to successfully acknowledge the SD1 messages (Contact your installation company for details).
2. No harm is done by not acknowledging the message as the unit simply repeats it four times and then aborts the call.
3. The procedure is fast and should be practised by all recipients under test conditions. The [8] button must be pressed within 2 seconds of each "beep" and should be held down for between $\frac{1}{2}$ to $1\frac{1}{2}$ seconds. If either tone is not 'seen' by the SD1 the message is repeated again.

7. Sending A Test Call

It is possible to test that each message plays to each of the telephone numbers. e.g., you may want to test that "Message A" plays to telephone number 1 or "Message B" to telephone number 3 etc.

Before sending a test call it is very important that the person that is being called is familiar with the Call Acknowledgement Procedure. This will ensure that the SD1 is successfully cleared down.

If the SD1 is not cleared down when it is triggered from the alarm panel it will either dial the next telephone number (if one is programmed) or re-dial the first telephone number a further two times.

The following example shows how to send "Message A" to telephone number 1:

Ensure that the SD1 is initialised and the display is showing "READY".

Dialling telephone No. 1

The unit waits until the phone being called is ringing. When the unit detects the ringing the display will show "RINGING". If ringing is not detected within 5 seconds the unit will start to play the message.

The unit plays phrase 0 (Name & Address) then the alarm phrase A (e.g., Fire Alarm etc.). At the end of phrase A, the person receiving the call should carry out the Call Acknowledgement Procedure.

If the call is successfully acknowledged the display will show "CALL SUCCESSFUL". If the person receiving the call fails to acknowledge it on the first attempt the unit will repeat the message four times, giving them the opportunity to acknowledge the call at the end of each message. However if at the end of the last attempt they still fail to acknowledge the call the display will show "NO REPLY". The unit will clear down for 6 seconds, then re-dial the telephone number a further two times.

Repeat for other test call combinations as required.

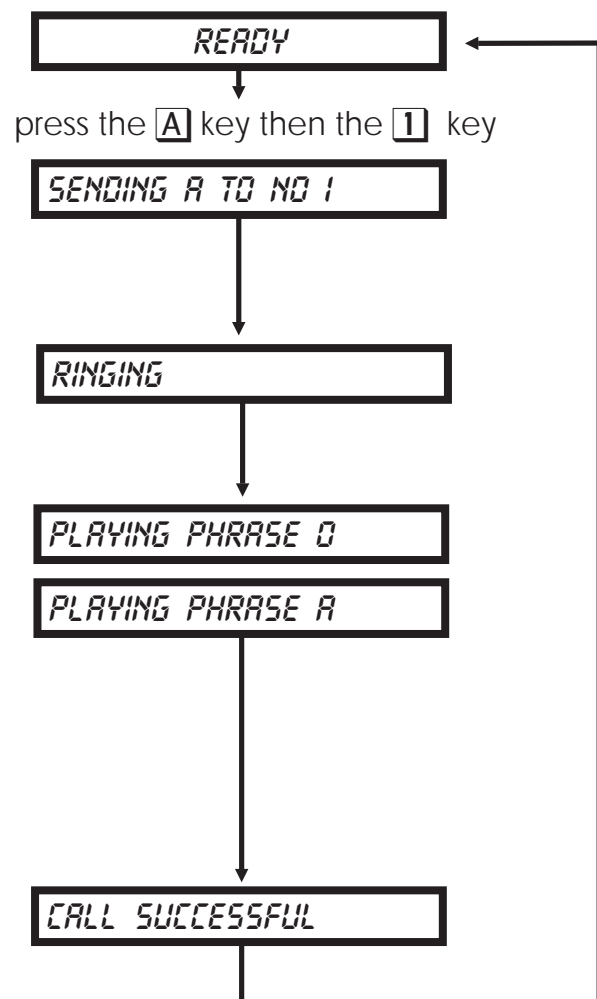

Test calls may be cancelled at any time by pressing the **ESC** key.

8. Test Activation

When the unit is triggered on one of the inputs A, B or C the display will show "-ON-" throughout the procedure. This test option allows you to test trigger one of the three inputs A, B or C. In the test mode the display will show the unit's actions.

The following example shows how to simulate a trigger on input A. The Acknowledgement option is set to "CLEARED BY ANY 1" (see page 7).

Ensure that the SD1 is initialise and the display shows "READY".

Dialling telephone No.1

Telephone is ringing

Message A is played

Dialling telephone No.2

Telephone is ringing

Message A is played

Dialling telephone No.3

Telephone is ringing

Message A is played

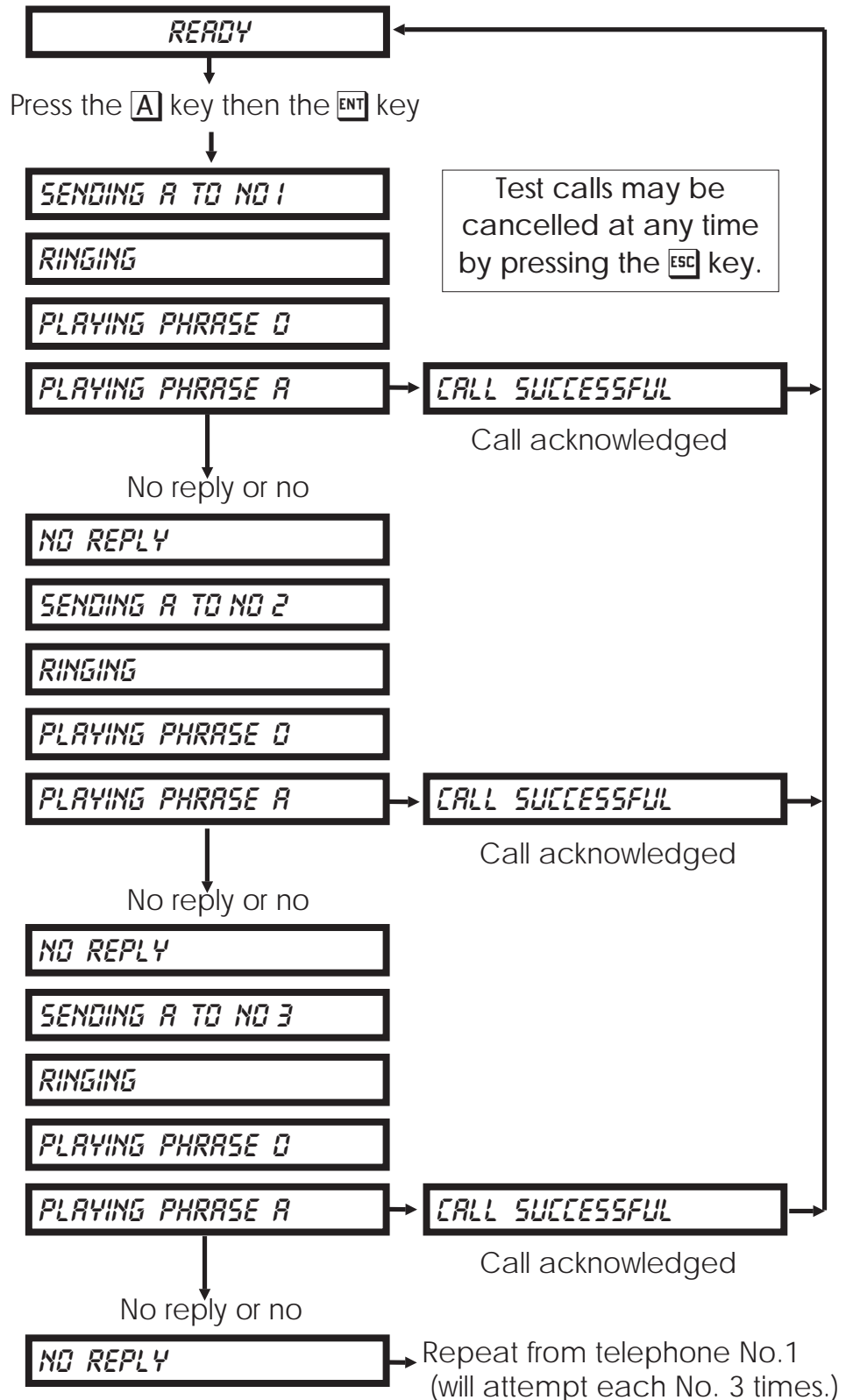

9. Changing the Acknowledgement Option

The SD1 acknowledgement can be set to one of the following options:

- CLEARED BY ANY 1: The SD1 will clear down when the message is acknowledged by any one of the three recipients.
- CLEARED BY ANY 2: The SD1 will clear down when the message is acknowledged by any two of the three recipients.
- CLEARED BY ALL 3: The SD1 will clear down when the message is acknowledged by all three recipients.

The default setting is "CLEARED BY ANY 1", which can be changed as follows:

Ensure that the SD1 is initialised and the display is showing "READY".

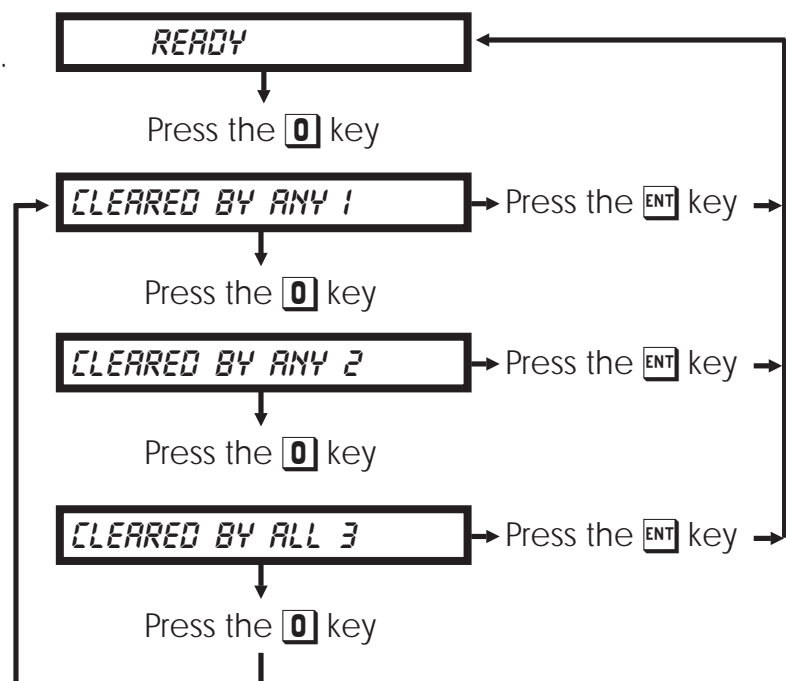

10. Viewing The Last Call Log

When a call is successfully acknowledged the SD1 stores the event in a "Last Call Log".

The log may then be viewed as follows:

Ensure that the SD1 is initialised and the display is showing "READY".

The display will show the Last Call Log e.g., "SENT A to [-2-]" (Alarm on trigger input A acknowledged by recipient 2). If the display shows [---] then none of the calls was acknowledged.

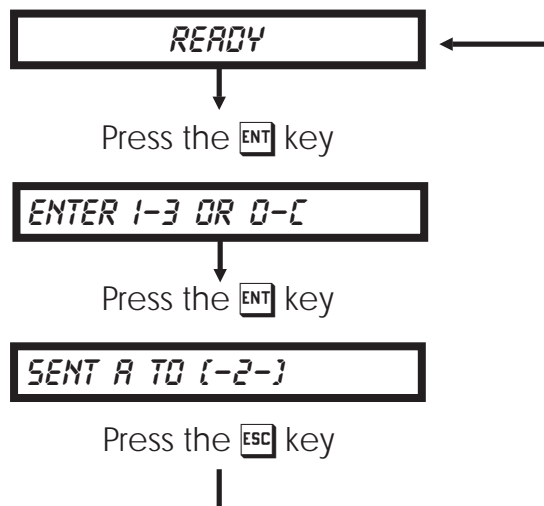

Press the **ESC** key to return to "READY"

11. Cancelling an Activation.

Occasionally you may trigger your alarm by accident and cause the SD1 to send an unwanted call. When this happens the unit cannot be stopped by pressing the **ESC** key or any of the other keys. Control of the SD1 is disabled until the call has been successfully acknowledged or until the unit has cleared down after the final attempt.

However there are two actions you may try to ensure that the alarm is intercepted:

1. If a telephone is connected on the same line as the SD1 you may lift the handset and talk over the top of the SD1 message. Advise the recipient of the call not to respond to the alarm.
2. If a telephone is connected on the same line as the SD1 you may use it to acknowledge the SD1 yourself (providing it is a tone type telephone).

12. Trouble-Shooting Guide

Problem	The unit will not dial the telephone number that I have programmed.
Cause	Number incorrectly dialled
Action	Check the telephone number you are calling has been entered correctly.
Problem	When sending a Test call the display shows:
Cause	The call was not answered or acknowledged by the recipient.
Action	Ring the recipient and check they have followed the call acknowledgement procedure.
Problem	When sending a Test call the the display shows:
Cause	The recipient is on another call.
Action	Wait until they have finished the call and try again.
Problem	When sending a Test call the display shows:
Cause	The SD1 has dialled the number and detected something other than a "ringing" or "engaged" tone (e.g., a B.T. or Cellnet recorded message).
Action	Check the number using a normal telephone or try again.
Problem	The unit is triggered from the Control Panel but the display shows:
Cause	This is the normal response.
Action	If you require to see the SD1 status condition when triggered, the use the "Test Activations" option (see section 8).
Problem	When the unit calls the recipient they can't acknowledge the unit by pressing the number [8] button.
Cause	Incorrect acknowledgement procedure.
Action	Instruct the recipient in the correct procedure (see section 6).
Cause	Incompatible telephone.
Action	Call the recipient and ask them to press the number [8] button on their telephone for 3 seconds. If you hear anything other than a 3 second tone, their telephone is not capable of acknowledging the SD1. This may be overcome by using a tone pad to simulate the modern dialling tones. Contact your installation company for further details.
Problem	The recipient has acknowledged the call but the SD1 continues to dial the second or third number.
Cause	The "Acknowledgement Option" is set to "CLEARED BY ANY 2" or "CLEARED BY ALL 3".
Action	Check the option is set to your required setting (see section 9).
Problem	The SD1 "beeps" every 30 seconds and the display shows:
Cause	The power supply to the SD1 has been interrupted.
Action	Re-program all telephone numbers and messages as required (contact your installation company for further advice if the the problem re-occurs).

QUICK REFERENCE GUIDE

NOTE: When the unit is first switched on the display shows "PLEASE RE-RECORD" and the unit beeps every 10 seconds. When the SD1 is not being used the display shows "-ON-". To initialise it press and hold the **ENT** key for 6 seconds.

If the unit is not operated for 1 minute, it will revert to its normal standby mode and the display will show

